

ALLABOARD

Boating Safety and Recreational Device
 Designed by C. W. "Red" Russell
THE AMERICAN NATIONAL RED CROSS



INSTRUCTIONS

8' x 16" x 1" (or 3/4" for 6' board or light-weight crew) marine ply.

Round edges and fiberglass edges and one side (epoxy resin).

Cut hand and foot holes approximately 5" x 2 1/2" (set back 2 1/2" or 3" from edges of board).

Secure cleats 3/4" x 3/4" glued and screwed to board 15" apart, flush with bases of foot and hand holes.

Splice rope grommet 1/2" dacron, 5' length (join ends with short splice), through rope holes 1/2" diameter for snug fit.

Give five coats marine spar varnish on natural side and two coats white epoxy paint on fiberglassed side and edges.

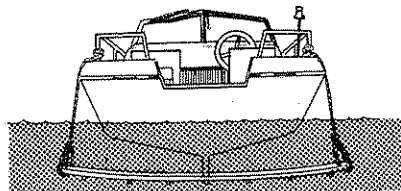

Flopperstopper To Prevent Rolling While at Anchor

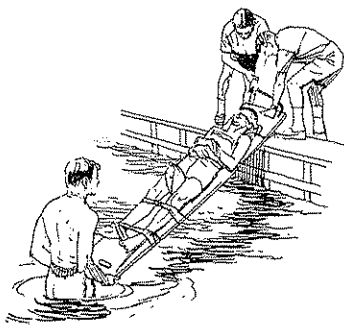

Litter for Sick or Injured Person, Either Aboard or in the Water

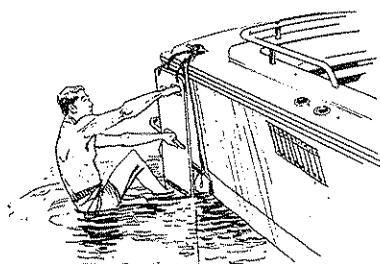

Ladder for Overboard Victim or Swimmer

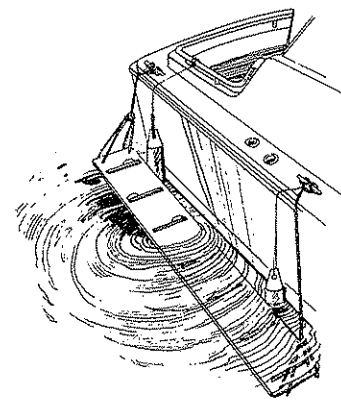
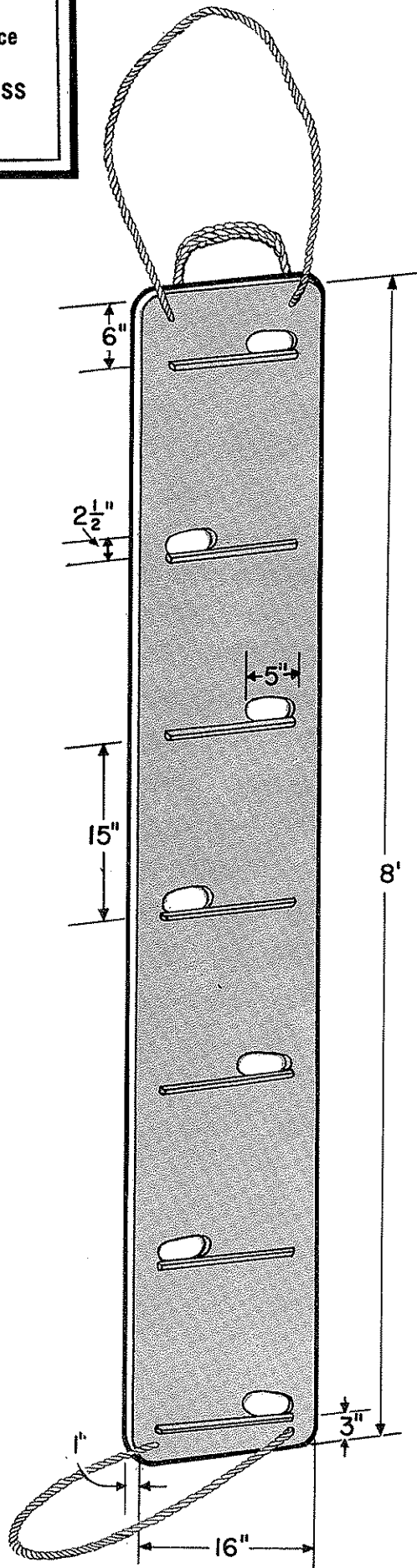

Swimming Ramp

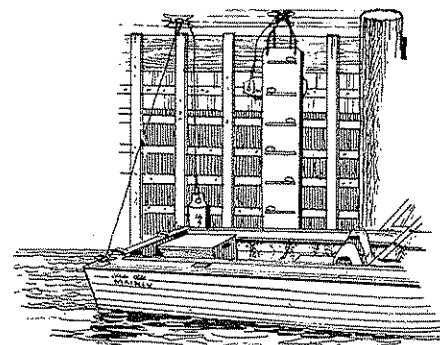

Ladder to Higher Elevation

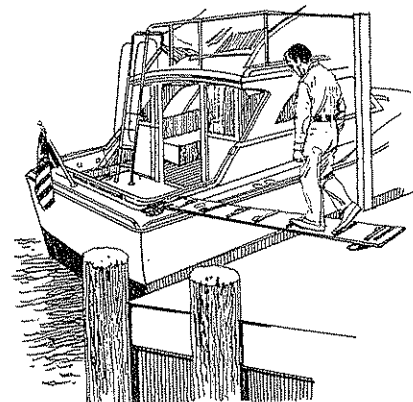

Gangplank

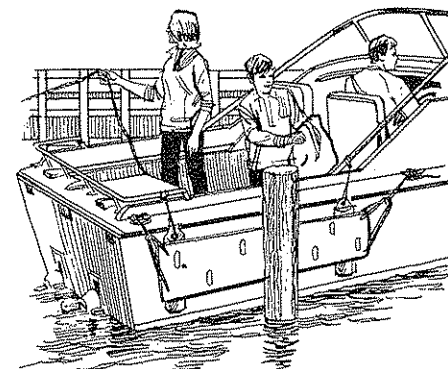

Fenderboard